

COMBINING AN AMPLIFIER WITH THE BUF634

By Uwe Vöhringer, Burr-Brown International GmbH

COMBINED OP AMP AND BUFFER ACHIEVE HIGHER OUTPUT POWER AND MORE SPEED

As long as amplifiers have existed, engineers have been dreaming of an “ideal” op amp. As little noise as possible, high bandwidth, great precision, unlimited input impedance, and output impedance close to 0Ω —these are specifications desirable for every application. Unfortunately, no op amp can fulfill all of these requirements, particularly not while remaining affordable. A good solution, therefore, is to combine two components, using the best of both parts to achieve desired specifications.

The following application note describes a combination using an op amp with the high-speed buffer BUF634 located in its feedback loop (see Figure 1). Depending upon the op amp selected, large signals with output currents of over 500mA into the MHz range can be attained.

Possible applications for this combination include cable drivers, virtual ground drivers for a dynamic load, or low distortion end stages for both audio and video signal generators. In this circuit configuration, the work is divided so that the op amp is responsible for precision while the buffer provides the necessary current. An important advantage of the combination is that the power dissipation is managed by the buffer. The op amp is loaded only by the low input current of the buffer amplifier. The temperature at the op amp is only slightly higher than in the no-load mode. The circuit parameters such as offset, drift, noise, and harmonic distortion depend almost entirely upon the op amp used in the circuit and have practically no influence on the configuration even when the temperature of the buffer rises. The combination was tested using four different op amps. The measurement diagrams in Figures 3 through 15 show the performance of the various combinations.

For low-end audio circuits, the OPA604 is used for low-noise and low-distortion applications at frequencies of up to about 100kHz. The OPA627, OPA671, and OPA603 are used for higher frequency applications. As already mentioned, the buffer is located in the feedback loop of the op amp. This configuration compensates the buffer's internal resistance so that the output resistance of the entire circuit is close to zero. At high frequencies with high loads, however, the internal resistance of the buffer increases, leading to a rise in distortion as well. For this reason, the circuit contains three BUF634T in parallel in order to achieve an output current of 500mA, even though two of these components would have sufficed for this current to be attained (see Figure 2).

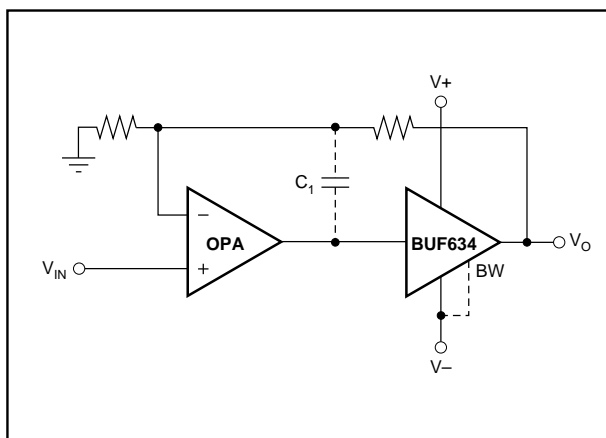

FIGURE 1. Composite Amplifier Using BUF634.

CALCULATING THE LOAD RESISTANCE (R_{LOAD}) FOR A 500mA OUTPUT CURRENT

The output voltage of the buffer was fixed at 15Vp-p for all measurements to ensure that the op amp would remain within its linear operating range. The circuit was configured at gain 2 since the input is terminated at 50Ω for the high frequency measurements. To achieve the 15Vp-p output voltage at gain 2, the following rms-input voltage is required:

$$V_{IN} = \frac{V_{OUT\ p-p}}{2 \cdot \sqrt{2} \cdot \text{Gain}} = \frac{15V\ p-p}{2 \cdot \sqrt{2} \cdot 2} = 2.652\ V_{rms}$$

The load resistance for a peak output current of 500mA equals:

$$\frac{15V\ p-p}{2 \cdot 500\ mA} = 15\ \Omega$$

The 50Ω series resistor at the buffer outputs provides reflection-free termination in the high-frequency range. No series resistors were used between the output of op amp A_1 and the buffer inputs since they would form a low-pass filter in combination with the input capacitance of the buffers. Any phase shift resulting from this low-pass could cause the entire circuit to oscillate, particularly when an op amp like the OPA603 is used.

When selecting the value of resistors R_F and R_1 , which determine the gain, it should be noted that R_F determines the bandwidth and stability for current-feedback op amps, they also determine the open-loop gain. Resistor values of $2.7k\Omega$

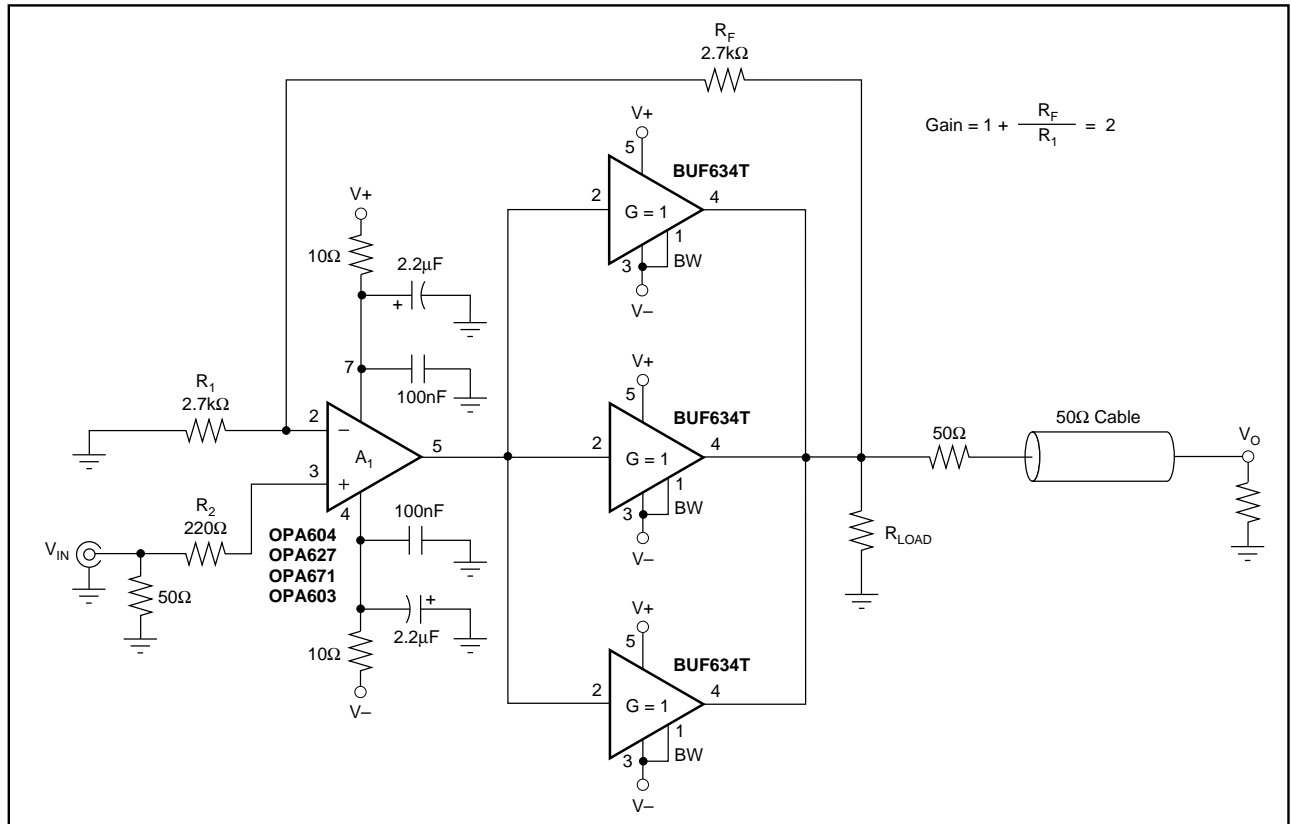

FIGURE 2. Circuit Schematic of the Final Composite Amplifier.

have proven to be a good value for this circuit. When the two resistors are lowered to 820Ω, the closed-loop gain still remains the following:

$$G = 1 + \left(\frac{820\Omega}{820\Omega} \right) = 2$$

The open-loop gain increases for the current-feedback amplifier, which would result in a higher chance of oscillation. For the voltage-feedback op amps (OPA604, OPA627 and OPA671), the resistors are less important since they do not influence the open-loop gain.

In composite amplifier circuits such as the one in Figure 1, a capacitor (C_1) is often located between the output of the op amp and its inverted input. This capacitor, along with R_1 and R_F , forms a low-pass filter which prevents high-frequency circuit oscillation. The high bandwidth of the BUF634 (180MHz) keeps both the group delay time and the phase shift low, avoiding the need for the capacitor. The advantage of this configuration is that the cutoff frequency is determined solely by the op amp. In current-feedback op amps such as the OPA603, a capacitor in the feedback loop could lead to stability problems. The output resistance of the BUF634 is about 10Ω. Therefore, series output resistors for decoupling the individual buffers are no longer necessary. At differing offset voltages, compensation currents flow because the buffers are in parallel to each other. Assuming

a typical offset voltage of $\pm 30\text{mV}$, the compensation current (I_C) between the buffers equals the following:

$$I_C = \frac{60\text{mV}}{2 \cdot 10\Omega} = 3\text{mA}$$

The maximum offset voltage of 200mV results in a compensation current of:

$$I_C = \frac{200\text{mV}}{2 \cdot 10\Omega} = 10\text{mA}$$

As expected, measurements using the four different op amps showed that for the audio range, the op amps OPA627, OPA671, and OPA604 produce lower harmonic distortion than the OPA603. Since harmonic distortion rises with frequency, the OPA604 should not be used above 50kHz, and the OPA627 should not be used above 100kHz. Between 100kHz and 1MHz, the OPA671 has significantly lower distortion than the OPA627 and the OPA604. Above 1MHz, however, the high-speed op amp OPA603 is the best choice.

Figure 3 through 15 show the harmonic distortion and Figures 16 through 19 show the frequency responses of the four op amps. Figure 3, 7, 11, and 14 show the harmonic distortions of the sine generator. This distortion affects the measurement diagrams as well, especially at frequencies of 1MHz and higher.

AC PERFORMANCE OF THE CIRCUIT

The AC performance of the circuit using the various op amps was measured using a spectrum analyzer at a 15Ω load.

The analyzer could only deliver a maximum output of 0dBm at 50Ω, corresponding to a voltage of 223mVrms. For this reason, the resistor R₁ at the inverting input of the op amp was reduced from 2.7kΩ to 120Ω, achieving a gain of:

$$G = 1 + \left(\frac{2.7\text{k}\Omega}{120\Omega} \right) = 23.5$$

At an input voltage of 223mVrms and a gain factor of 23.5,

the resulting buffer output voltage is 5.241Vrms. The peak value is calculated as follows:

$$V_p = 5.241\text{V} \cdot \sqrt{2} = 7.4\text{V}_p \text{ (or } 14.8\text{V}_{p-p}\text{)}$$

When R_{LOAD} is 15Ω, the peak current is 494mA. It is clear that only the current-feedback op amp OPA603 can be used for high frequencies (f_g = 23MHz).

For higher outputs in the audio range, the OPA541 can be used instead of the BUF634.

PROTECTION CIRCUITRY

Since the BUF634 is equipped with a short-circuit and a thermal protection, no extra protection circuitry is necessary.

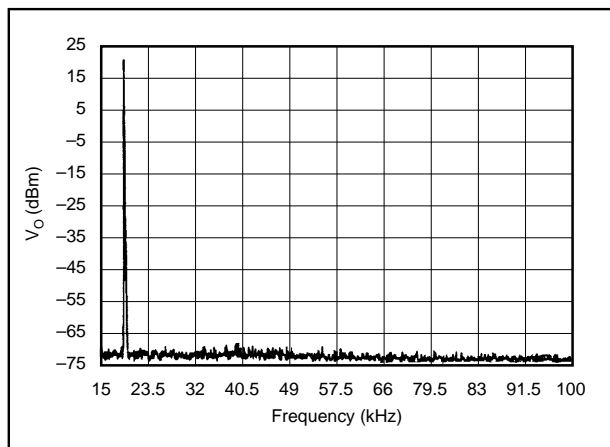

FIGURE 3. Spectrum of the Sine Generator at 20kHz.

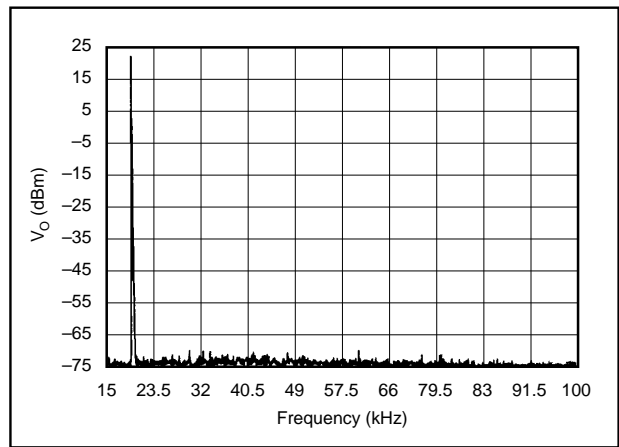

FIGURE 4. Spectrum of the BUF634T with the OPA604/627 at 20kHz, G = 2.

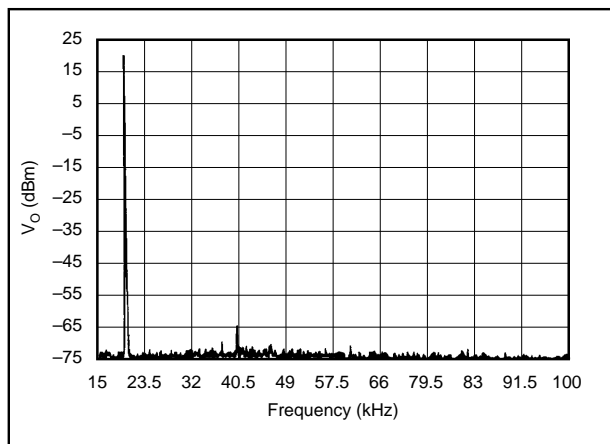

FIGURE 5. Spectrum of the BUF634T/OPA671 at 20kHz, G = 2.

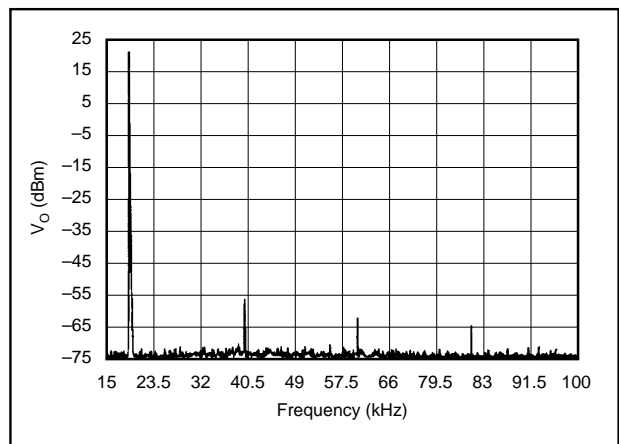

FIGURE 6. Spectrum of the BUF634T/OPA603 at 20kHz, G = 2.

The information provided herein is believed to be reliable; however, BURR-BROWN assumes no responsibility for inaccuracies or omissions. BURR-BROWN assumes no responsibility for the use of this information, and all use of such information shall be entirely at the user's own risk. Prices and specifications are subject to change without notice. No patent rights or licenses to any of the circuits described herein are implied or granted to any third party. BURR-BROWN does not authorize or warrant any BURR-BROWN product for use in life support devices and/or systems.

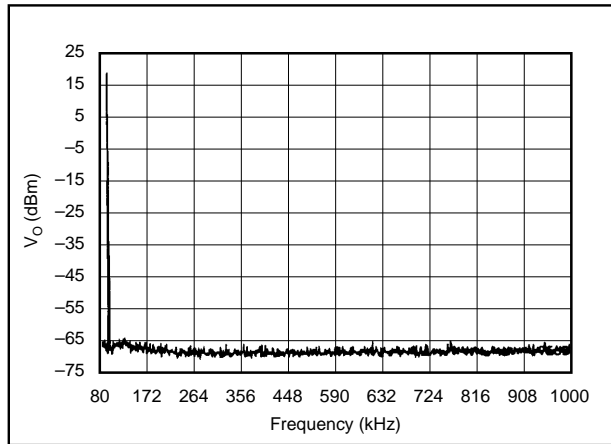

FIGURE 7. Spectrum of the Sine Generator at 100kHz.

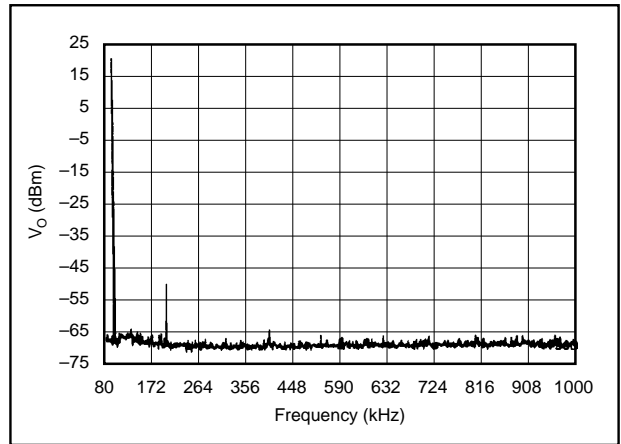

FIGURE 8. Spectrum of the BUF634T/OPA627 at 100kHz, $G = 2$.

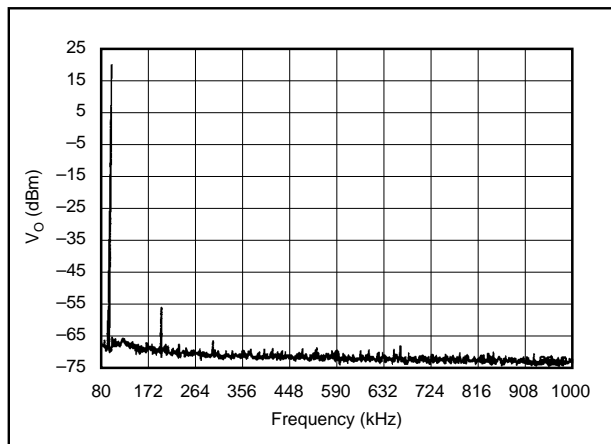

FIGURE 9. Spectrum of the BUF634T/OPA671 at 100kHz, $G = 2$.

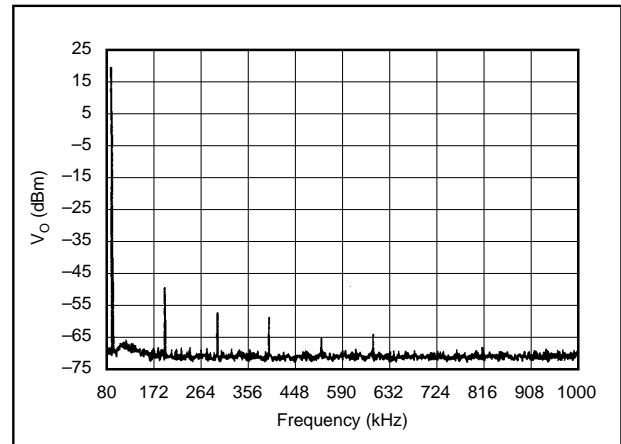

FIGURE 10. Spectrum of the BUF634T/OPA603 at 100kHz, $G = 2$.

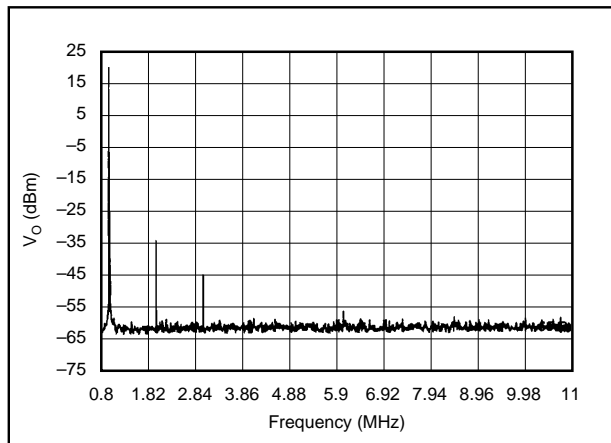

FIGURE 11. Spectrum of the Sine Generator at 1MHz.

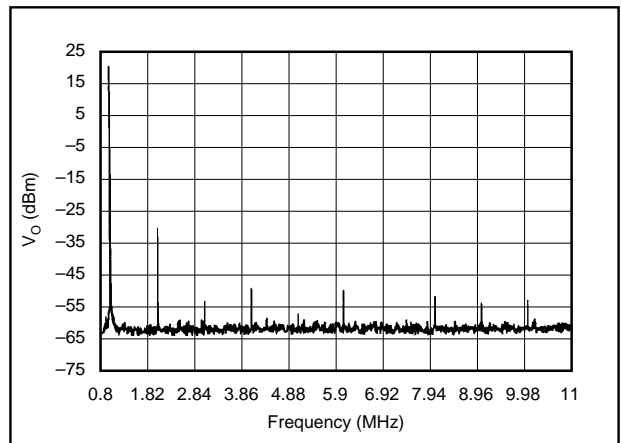

FIGURE 12. Spectrum of the BUF634T/OPA671 at 1MHz, $G = 2$.

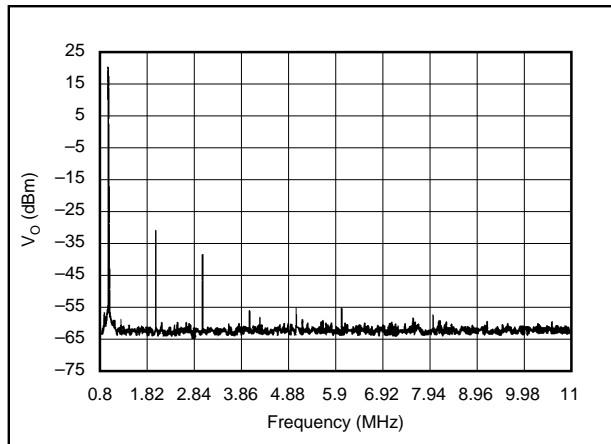

FIGURE 13. Spectrum of the BUF634T/OPA603 at 1MHz. $G = 2$.

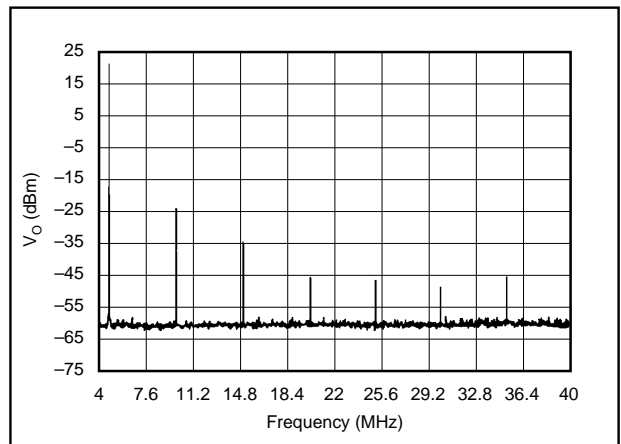

FIGURE 14. Spectrum of the Sine Generator at 5MHz.

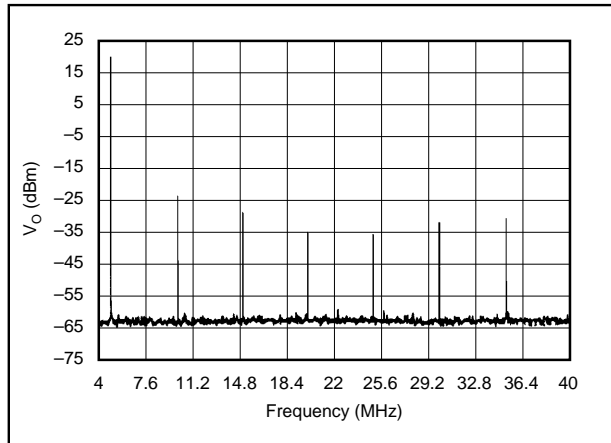

FIGURE 15. Spectrum of the BUF634T/OPA603 at 5MHz. $G = 2$.

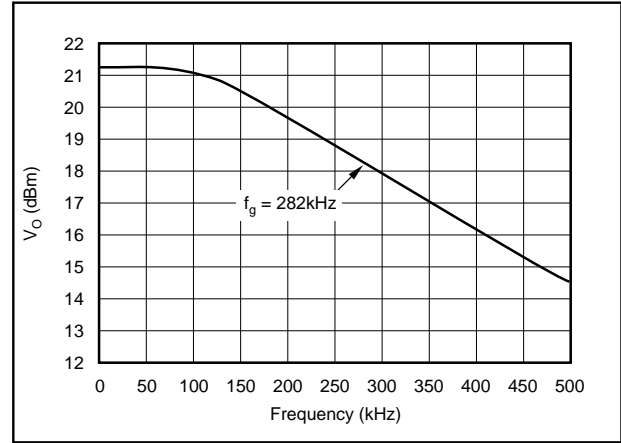

FIGURE 16. Frequency Response of the OPA604 ($G = 23$).

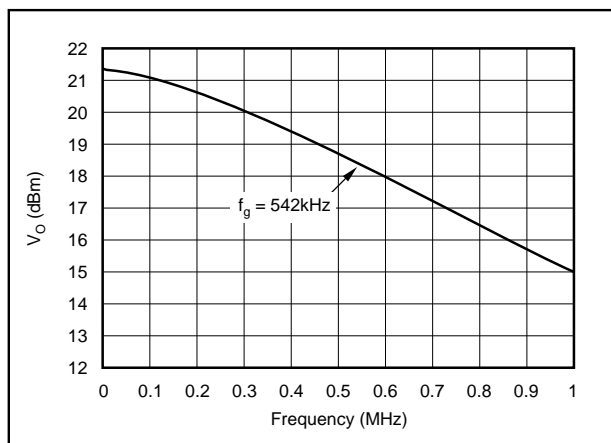

FIGURE 17. Frequency Response of the OPA627 ($G = 23$).

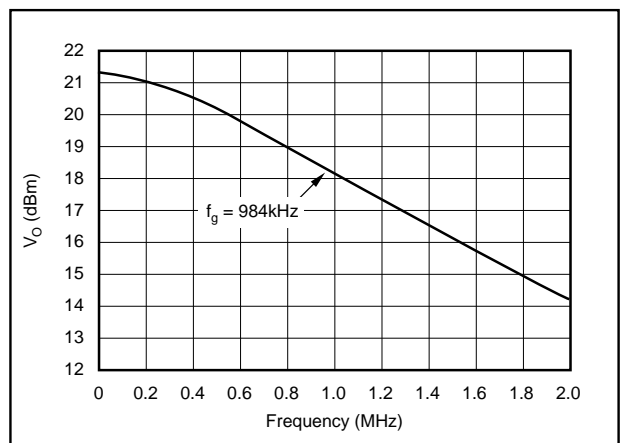

FIGURE 18. Frequency Response of the OPA671 ($G = 23$).

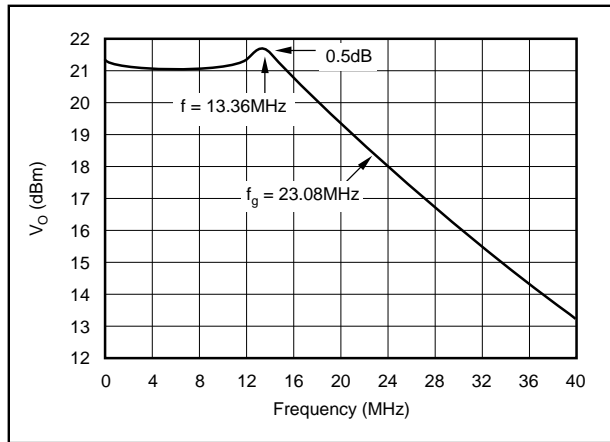

FIGURE 19. Frequency Response of the OPA603 ($G = 23$).

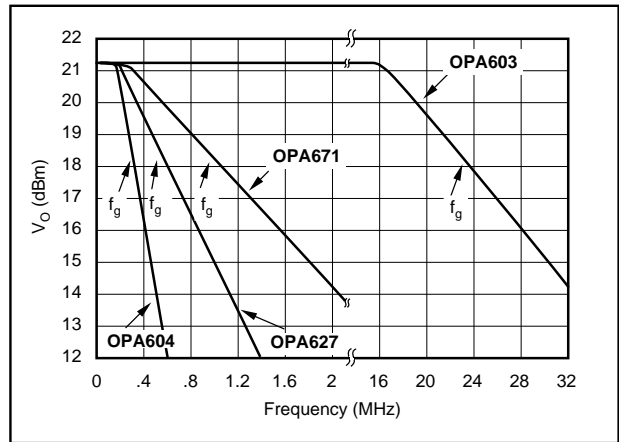

FIGURE 20. Frequency Responses of the Four Op Amps ($G = 23$).